

C1SL42 INSTALL GUIDE

DIMENSIONAL RENDERINGS

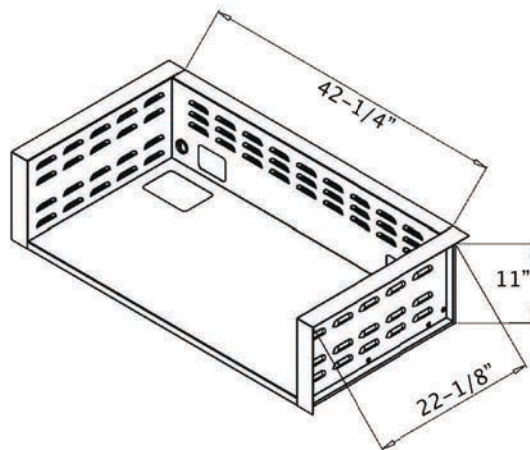
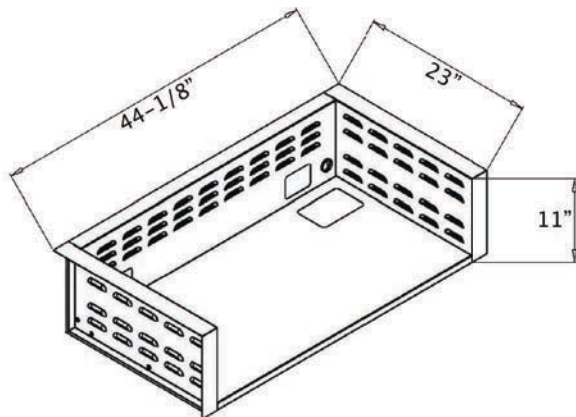
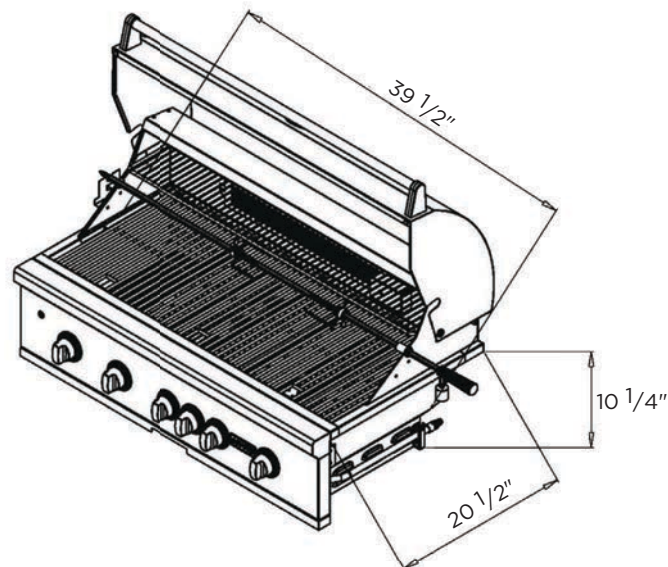
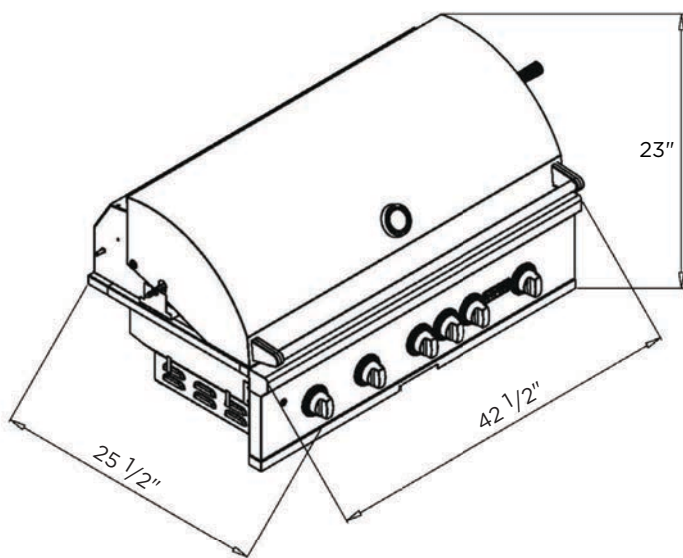

Overall Product Dimensions			
Model No.	Height	Width	Depth
C1SL42	23"	42 1/2"	25 1/2"
CJAKTCS42	11"	44 1/8"	23"

Cutout Dimensions for Island			
Model No.	Height	Width	Depth
C1SL42	10 1/4"	39 1/2"	20 1/2"
CJAKTCS42	11"	42 1/4"	22 1/8"

✓ When using a Coyote insulated jacket, you will want to build your island to the jacket's Cutout and Overall Dimensions listed above (detailed on 2nd page). Once the jacket is installed, the grill will rest on/inside the insulated jacket

Model No.	Gas Supply	BTU's	Regulator	WC Pressure	Max PSI	Electrical Requirements
C1SL42LP	Propane	110,000	20 lb Tank Regulator	11"	.5 PSI	Qty 1 - 120 VAC 60 Hz Grounded Plug
C1SL42NG	Natural Gas	110,000	1/2" Female Pipe	4"	.5 PSI	Qty 1 - 120 VAC 60 Hz Grounded Plug

Important Note to Installer: This file is not intended to replace your Owners' Manual which contains specific safety requirements and consumer guidelines. Please refer to your Owners' Manual prior to installing or operating your built-in grill.

C1SL42 INSTALL GUIDE

NON-COMBUSTIBLE CONSTRUCTION

Insulated Jacket NOT Required

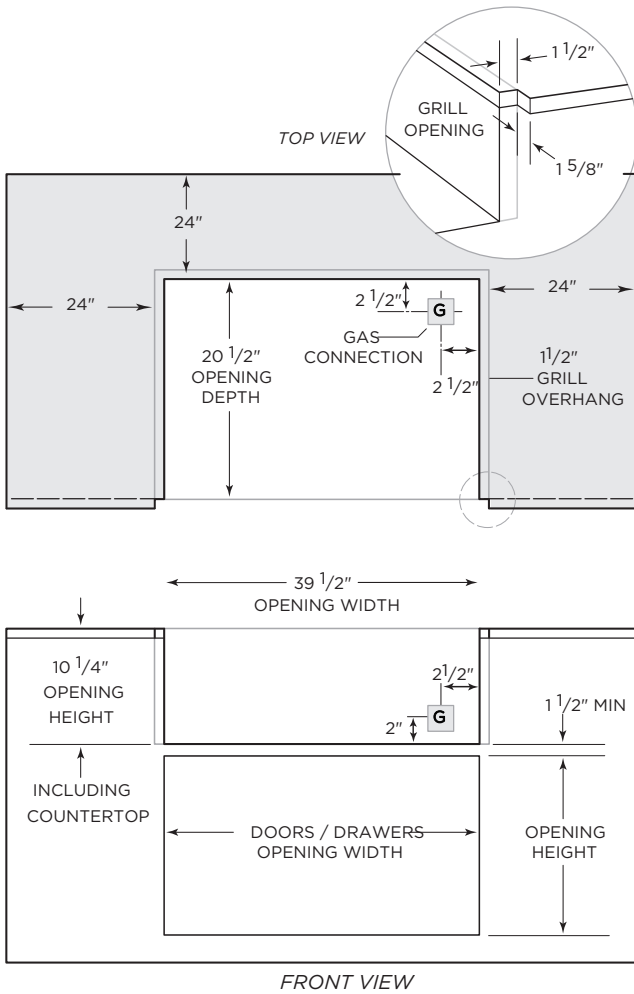

- ✓ Combustible material can not be within 24" of the grills frame
- ✓ This applies to all directions - horizontal & vertical
- ✓ Shaded area above on "TOP VIEW" illustrates the 24" minimum requirement (not to scale for rendering purposes)
- ✓ The grill is designed to hang from the counter top with no support underneath
- ✓ Minimum rear clearance for the hood to open is 2"
- ✓ If you have a wall/partition behind the grill, the minimum rear clearance to that wall should be at least 7" to allow for ventilation of the exhaust

COMBUSTIBLE CONSTRUCTION

Insulated Jacket Required - Model # CJAKTCS42

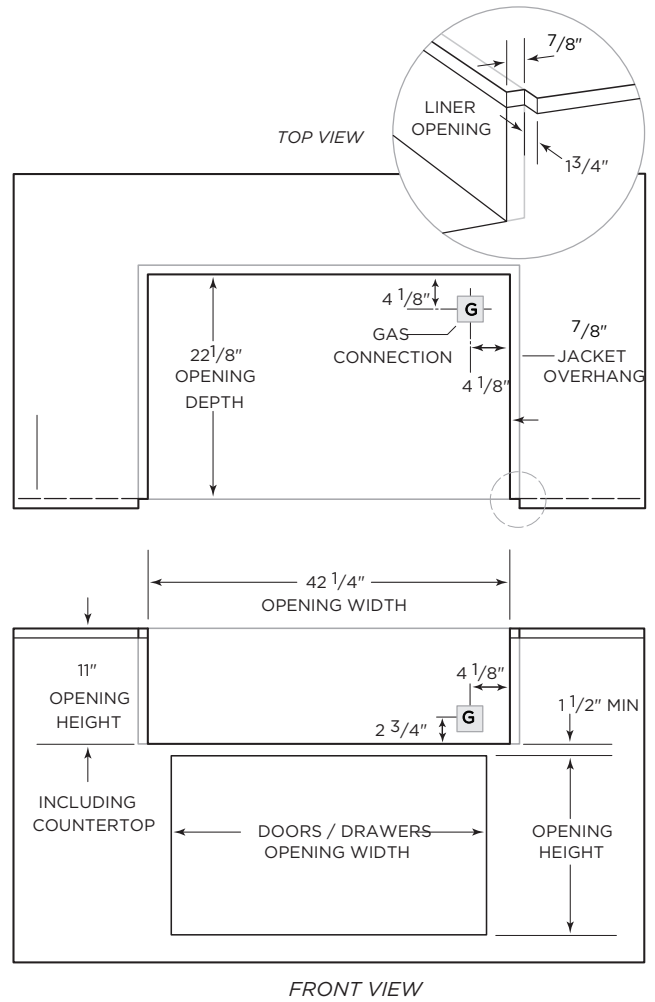

- ✓ If using combustibile material within 24" of the grill frame, you MUST use the corresponding Coyote Insulated Jacket
- ✓ Using a insulated jacket, does not waive any other standard installation procedure (ventilation, connections, etc)
- ✓ The jacket is designed to hang from the counter top with no support underneath
- ✓ Minimum clearance for hood to open is 2"
- ✓ If you have a wall/partition behind the grill, the minimum rear clearance to that wall should be at least 7" to allow for ventilation of the exhaust

Ventilation Requirements:

- ✓ Regardless if you are using a combustibile or non-combustibile building material, you must include at least two vents within the island.
- ✓ These vents must be at least 20 sq. in. each and allow fresh air to move from the grill cabinet to the exterior environment.
- ✓ For a propane setup, the vents should be installed lower as propane is heavier than air.
- ✓ For a natural gas setup, the vents should be located higher in the island, as natural gas is lighter than air.
- ✓ Do not locate the two vents on the same wall of the island. Cross ventilation is key to allow any excess heat or trapped gas to dissipate.

Important Note to Installer: This file is not intended to replace your Owners' Manual which contains specific safety requirements and consumer guidelines. Please refer to your Owners' Manual prior to installing or operating your built-in grill.